

Notes: (Note briefly what you immediately notice about this design)

DATE:  
February 20, 2023

TITLE:  
RCP

DRAWING NUMBER:

**A**

### Lighting and Device Schedule

Device	Description	Manufacturer Part Number	Size	Qty	Power ea (watts)	Budgeted Power (Watts)
A	4" Color Tuning Gimbal Down Fixtures - White	PoE Texas DWN-4-RDG-WH	4"	4	10	10
B	4 foot Color Tuning Suspended Fixture - White	PoE Texas DENT-LTG-LR-4'-6	4'	1	40	40
C	IR Motion Detector - White	PoE Texas DENT-OCC-LV-P-Z-CM	3"	1	3	3
D	10" Wall Mounted Wallstation Controller	PoE Texas DENT-TAB-10	10"	1	12	12
E	4 Button Momentary Pushbotton Switch	PoE Texas DENT-WS-S4	1 gang	1	3	3

**Notes: (Note briefly what you immediately notice about this design)**

**PoE Lighting Bootcamp  
Template**

3616 Far West Blvd  
Suite 117-294  
Austin TX 78731

DATE:  
February 20, 2023

TITLE:  
**DEVICE  
SCHEDULE**

DRAWING NUMBER:

**B**

**Sequence of Operations:**

- 4 button switch:
  - a) Top button shall increase the brightness of all fixtures by 20%
  - b) Second button shall decrease the brightness of all fixtures by 20%
  - c) Third button shall increase the color temperature by 20%
  - d) Fourth button shall decrease the color temperature by 20%
- Motion Detector:
  - a) When the space is occupied, the occupant must turn on the lights manually
  - b) 20 minutes after the space is unoccupied, lights shall dim to 30% of maximum
  - c) 30 minutes after the space is unoccupied the lights shall turn off
- Customized Wallcontroller
  - 1) Shall be able to operate 4" downlights as a group
  - 2) Shall be able to operate 4' pendant light levels independently
  - 3) Shall be able to produce an alarm

**Notes: (Note briefly what you immediately notice about this design)**

DATE:  
February 20, 2023

TITLE:  
**CONTROLS  
NARRATIVE**

DRAWING NUMBER:

**C**

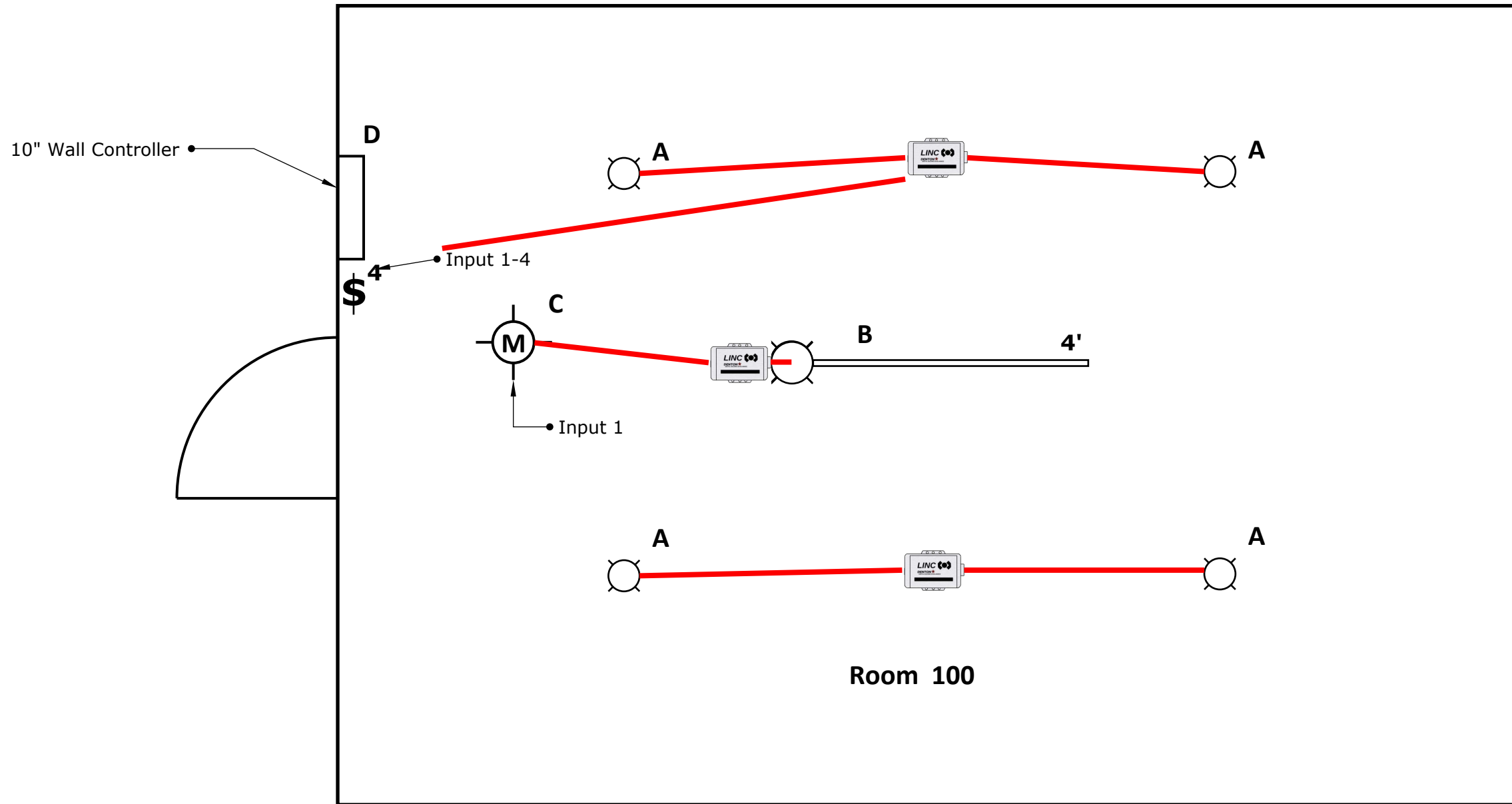

**Steps:**

How many LINC's will you need for this space? Please mark how many LINC's are needed for this space by drawing them in

Mark where you will install the LINC's (you can choose server room) then draw onelines for how you will run the wiring

**Considerations:**

- LINC's have four inputs and four outputs
- LINC's have a total power budget of 80 watts

Fixture A requires two outputs because it is color tuning - 1x for warm light and 1x for cool light

Each button on the 4 button switch needs its own input. All LINC's have 4x inputs so select the most convenient one



DATE:  
February 20, 2023

TITLE:  
PoE LIGHTING

DRAWING NUMBER:

**D**

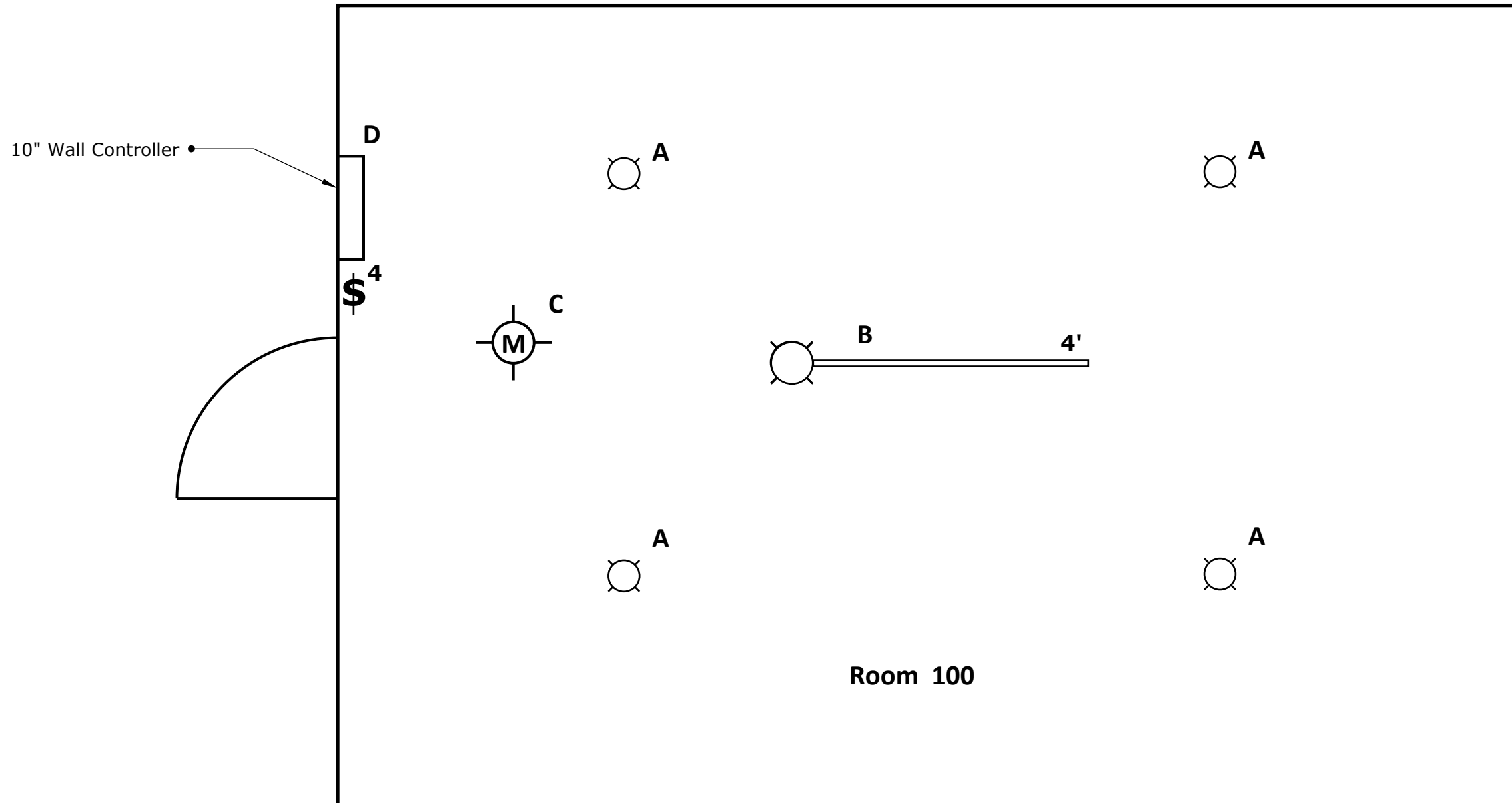

**Steps:**

Based on the drawings what other devices are in the system besides the lights and light switch? Which ones are PoE? **Wallswitch, wired. 10" Wall Controller-PoE. Occupancy/Motion, wired.**

**Considerations:**

At a minimum each deployment must have a COR-TAP controller

The 10" wall controller is Power Over Ethernet

The "M" device is a motion detector with a 0-10 volt range

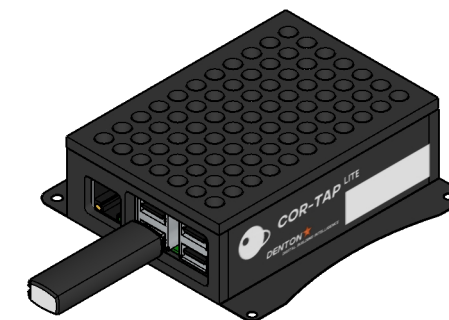

DATE:  
February 20, 2023

TITLE:  
**ACCESSORIES**

DRAWING NUMBER:

**E**

## Lighting and Device Schedule

Device	Description	Manufacturer Part Number	Size	Qty	Power ea (watts)	Budgeted Power (Watts)
A	4" Color Tuning Gimbal Down Fixtures - White	PoE Texas DWN-4-RDG-WH	4"	4	10	10
B	4 foot Color Tuning Suspended Fixture - White	PoE Texas DENT-LTG-LR-4'-6	4'	1	40	40
C	IR Motion Detector - White	PoE Texas DENT-OCC-LV-P-Z-CM	3"	1	3	3
D	10" Wall Mounted Wallstation Controller	PoE Texas DENT-TAB-10	10"	1	12	12
E	4 Button Momentary Pushbotton Switch	PoE Texas DENT-WS-S4	1 gang	1	3	3

Device				Controls		
Room	Type	Size	Power(max)	Node Name	Output or Input	MAC address (last 4)
100	A	4"	10	F100A_1_2	1_2	00:AC
100	A	4"	10	F100A_3_4	3_4	00:AC
100	A	4"	10	F100_1_2	1_2	00:BC
100	A	4"	10	F100_3_4	3_4	00:BC
100	B	4'	40	F100B_1	1	00:A1
100	C		3	S100C_1	1 (input)	00:AC
100	D	10"	12	WS100	N/A	N/A
100	E		3	SW100D_1_2_3_4	1_2_3_4	
100			12	COR-TAP-29		

### Steps:

Complete the PoE Schedule by adding a fixture A to row 3 and adding the MAC address from your kit in the 3x blank MAC address fields

### Considerations:

You want to identify each device and how much power it draws so you can create a power schedule for your networking hardware

You are also starting to use labeling. Either match the device labeling scheme provided by the owner or you can use ours developed over many projects:

F [Type of Device] 100 [Room number] A [Device schedule] \_1\_2 [Channels] 00:AC [Last 4 MAC]

The LINC MAC address is a unique identifier. You can choose to add them now or add them later

- **F - Light fixture**
- **SW - Light switch**
- **M - Motion detector**
- **WS - Wallstation**
- **S - Sensor (Various)**
- **SH - Shade**



## PoE Lighting Bootcamp Template

3616 Far West Blvd  
Suite 117-294  
Austin TX 78731

DATE:  
February 20, 2023

TITLE:  
PoE SCHEDULE

DRAWING NUMBER:

F

## Power Schedule

Device				Controls		
Room	Type	Size	Power(max)	Node Name	Output	MAC address (last 4)
100	A	4"	10	F100A_1_2	1_2	00:AC
100	A	4"	10	F100A_3_4	3_4	00:AC
100	A	4"	10	F100_1_2	1_2	00:BC
100	A	4"	10	F100_3_4	3_4	00:BC
100	B	4'	40	F100B_1	1	00:A1
100	C		3	S100C_1	1 (input)	00:AC
100	D	10"	12	WS100	N/A	N/A
100	E		3	SW100D_1_2_3_4	1_2_3_4	

### PSE Total Power Schedule

PSE	PSE Power Budget	Total power (kW)
GBTS-28-24-M_1_1	2,160W	104W

### PSE Power Schedule by Port

Node	Power (W)	Mfg	PSE Port
F100A_00:AC	20	DENT	GBTS-28-24-M_1_1
F100_00:BC	20	DENT	GBTS-28-24-M_1_2
F100B_00:A1	40	DENT	GBTS-28-24-M_1_3
WS100	12	DENT	GBTS-28-24-M_1_4
COR-TAP	12	DENT	GBTS-28-24-M_1_5

#### Steps:

Translate the PoE Device Schedule from the previous page into a Port and Switch Schedule - Add the LINC from your lab kit to the PSE Power Schedule by Port

#### Considerations:

Make sure to identify the power you need

What lights need to be on their own switch for emergency lighting?

How you will label the switches? Has the owner provided a schema?



**PoE Lighting Bootcamp Template**

3616 Far West Blvd  
Suite 117-294  
Austin TX 78731

DATE:  
February 20, 2023

TITLE:  
**POWER SCHEDULE**

DRAWING NUMBER:

**G**

**FOR EXAMPLE**

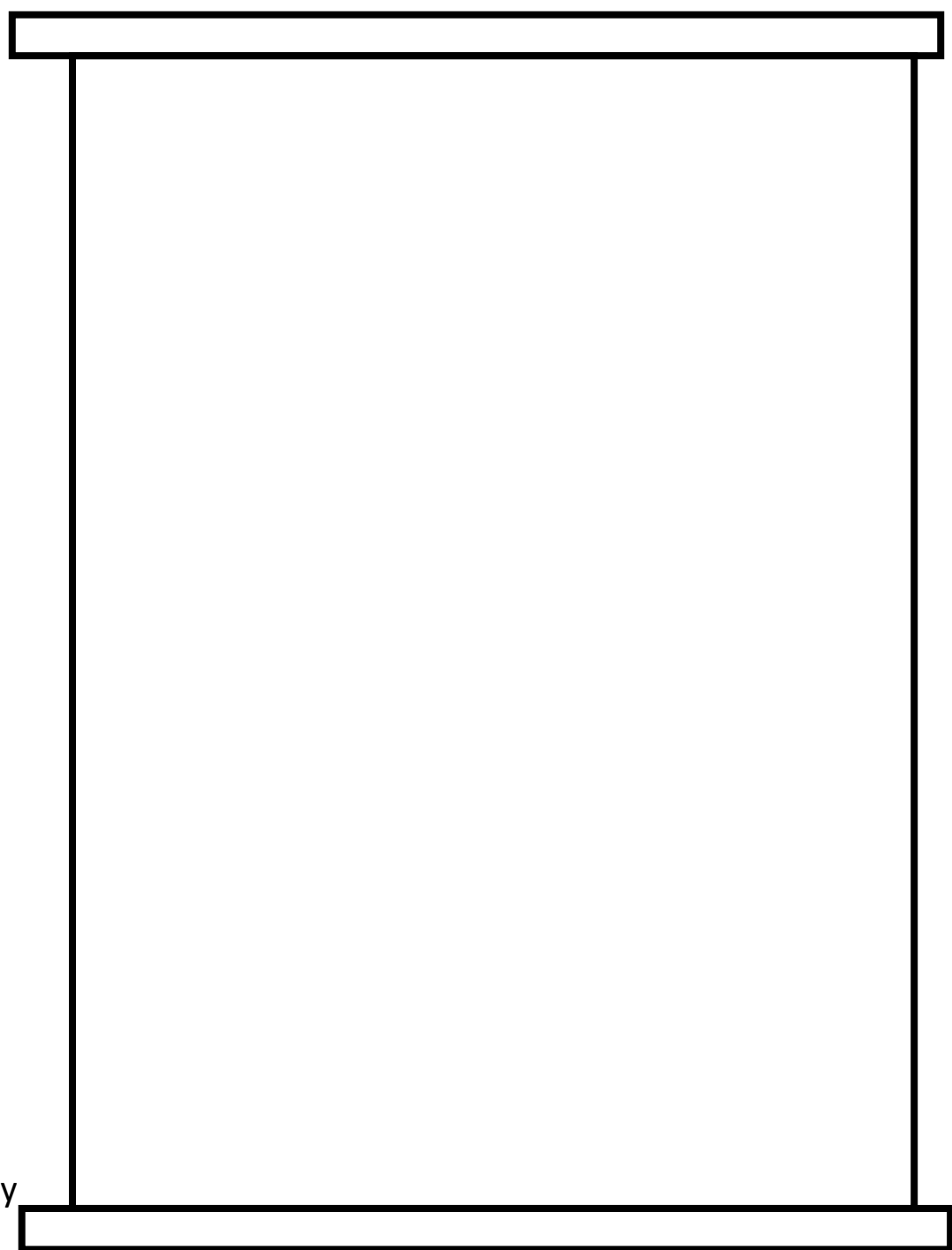
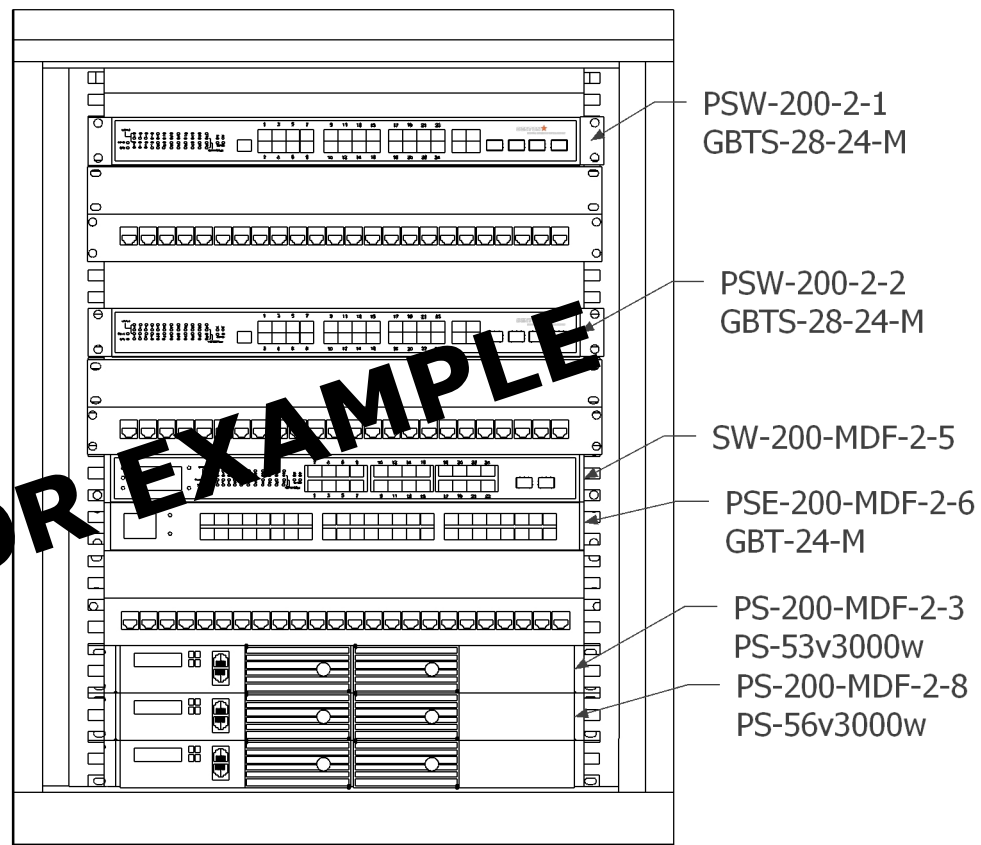

**Steps:**

Free hand draw your rack schedule - Add your GBTS-28-24-M and a power supply

**Considerations:**

The 1x GBTS-28-24-M can be powered by 1x PS-53v3000w on 120VAC for a total budget of 2,160 watts  
or 2x GBTS-28-24-M can be powered by 1x PS-53v3000w on 240VAC for a total power budget each of 2,160 watts

Allow rack space for proper ventilation around switches and power supplies

How many AC circuits at what amp do you need for this rack? Watts/Volts AC = Amps AC

DATE:  
February 20, 2023

TITLE:  
**RACK/SWITCH  
SCHEDULE**

DRAWING NUMBER:

## DENT-LTG-DWN

### Features

- ◊ CREE LED, high lumen
- ◊ 26mm (~ 1" ) thin profile
- ◊ 900+ Lumens
- ◊ UGR<19
- ◊ Several lensing options
- ◊ 90+ CRI
- ◊ 10W @ 90lm/W
- ◊ Constant Current: 200mA, 36-42VDC
- ◊ 2700K—5000K selectable via software
- ◊ Beam Angle 38°
- ◊ Weight 146g
- ◊ Operating Temp -10°- 40° C
- ◊ Dimming in 0.4% increments

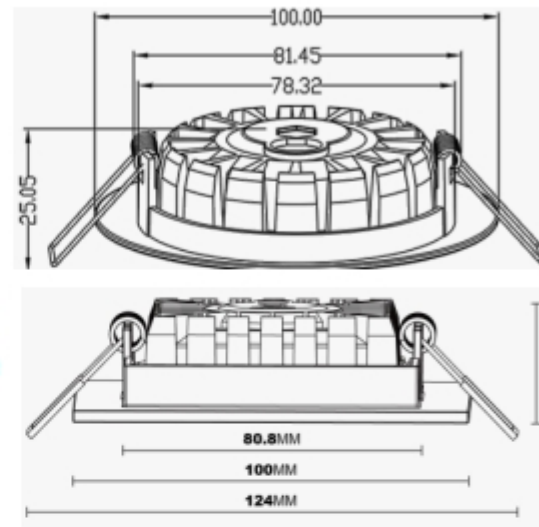

### 4" Style Options (DENT-LTG-DWN-4-<shape>-<color>)



<shape>	Description
-RDF-	Round Flat
-RDG-	Round Gimbal
-SQF-	Square Flat
-SQG-	Square Gimbal

<color>	Description
-WHT	White
-BLK	Black

512-479-0317

Since 2011 poetexas.com



## DENT-LTG-DWN

## Denton Linear Suspended Fixtures

### Features

- ◊ Narrow 1.3" width
- ◊ 2', 4' 8" length options
- ◊ All models support lumen control on up-light and downlight independently
- ◊ Low voltage PoE CC driver interface
- ◊ CRI Ra > 80
- ◊ 150 deg upright beam angle
- ◊ Power - 10W/ft
- ◊ 110lm/W ;
- ◊ 900-1200 lm/ft (depending on optics)
- ◊ 5 yr. warranty (longer options available)

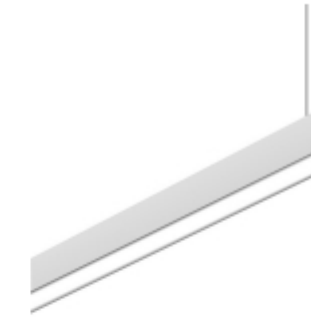

### Ordering Options

(DENT-LTG-LS-<length>-<cct>-<optics>-<mount>)

<length>	<cct>	<optics>	<mount>
2 - 2'	3000K	D - diffuser	W - wall
4 - 4'	3500K	R - recess reflector	S - surface
8 - 8'	4000K	L - louver	P - pendant
	5000K	C - convex	

### Physical Sizes

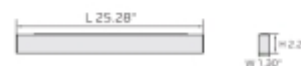

512-479-0317

Since 2011 poetexas.com



### Steps:

Mark the submittals as how you would submit them to the client. On DENT-LTG-DWN, circle the color that matches the color of the fixture in your lab kit.

### Considerations:

Identify selections of color, length, power, type. The better you identify them now the less risk you have later.

DATE:  
February 20, 2023

TITLE:  
SUBMITTAL  
PACKAGE

DRAWING NUMBER: