

DENT-LTG-DWN

PoE Down Lights

PoE Texas provides a variety of downlights specifically tested and supported by many PoE drivers including the DENT-LINC device. With one fixture per output, each fixture can be individually controlled and its power measured by the DENT-LINC



PoE Down Lights

This family of downlights come in a variety of sizes, styles, shapes and colors and is designed to retrofit into existing applications. When connected to constant current drivers such as the DENT-LINC-CC, you will achieve independently controllable brightness and CCT (2700K - 5000K) through an auto-configuration sequence. These fixtures provide low voltage replacement to existing high voltage alternatives and seamlessly plug into any PoE controls platform.

DENT-LTG-DWN

Features

- ◇ CREE LED, high lumen
- ◇ 26mm (~ 1") thin profile
- ◇ 900+ Lumens
- ◇ UGR<19
- ◇ Several lensing options
- ◇ 90+ CRI
- ◇ 10W @ 90lm/W
- ◇ Constant Current: 200mA, 36-42VDC
- ◇ 2700K—5000K selectable via software
- ◇ Beam Angle 38°
- ◇ Weight 146g
- ◇ Operating Temp -10°– 40° C
- ◇ Dimming in 0.4% increments

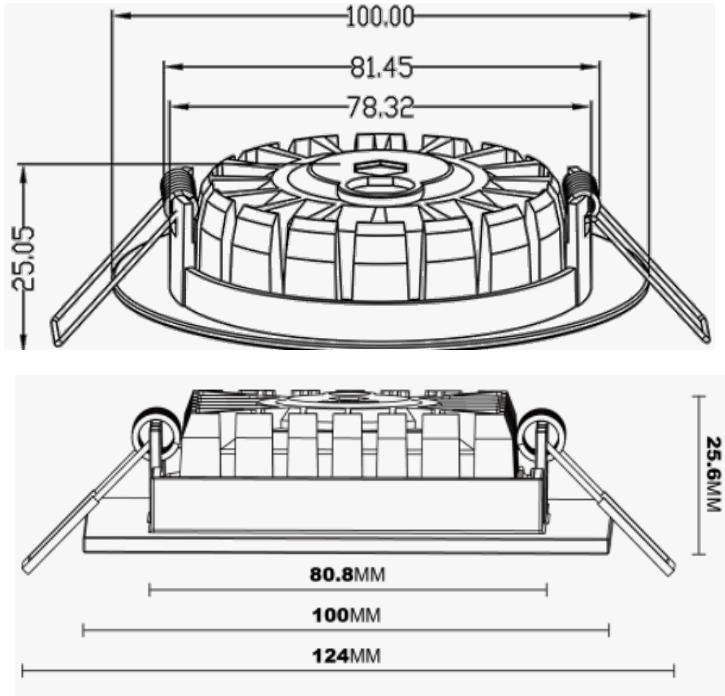

4" Style Options (DENT-LTG-DWN-4-<shape>-<color>)

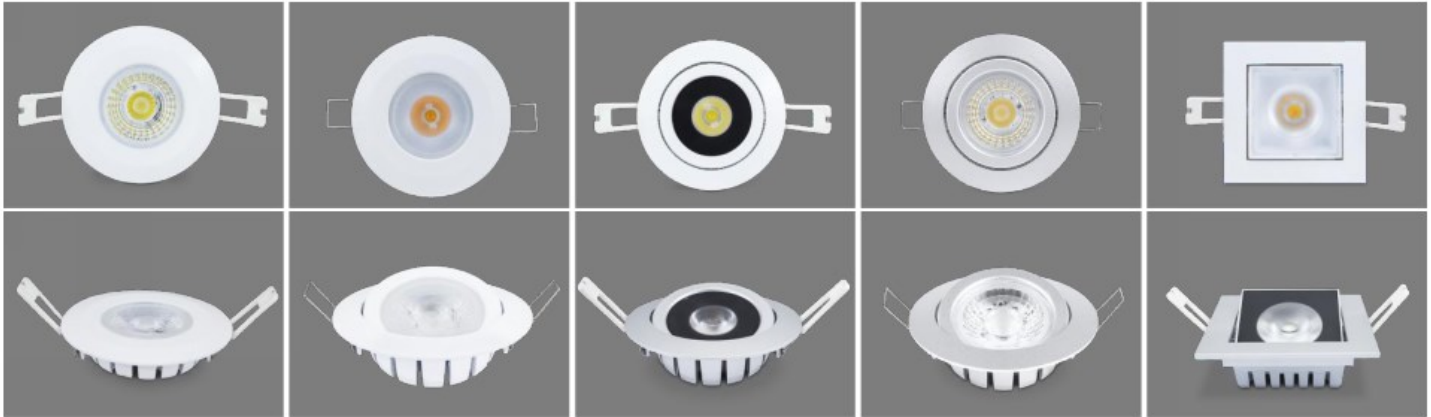

<shape>	Description
-RDF-	Round Flat
-RDG-	Round Gimbal
-SQF-	Square Flat
-SQG-	Square Gimbal

<color>	Description
-WHT	White
-BLK	Black

Performance

IES test result of ROUND ceiling downlight 38°

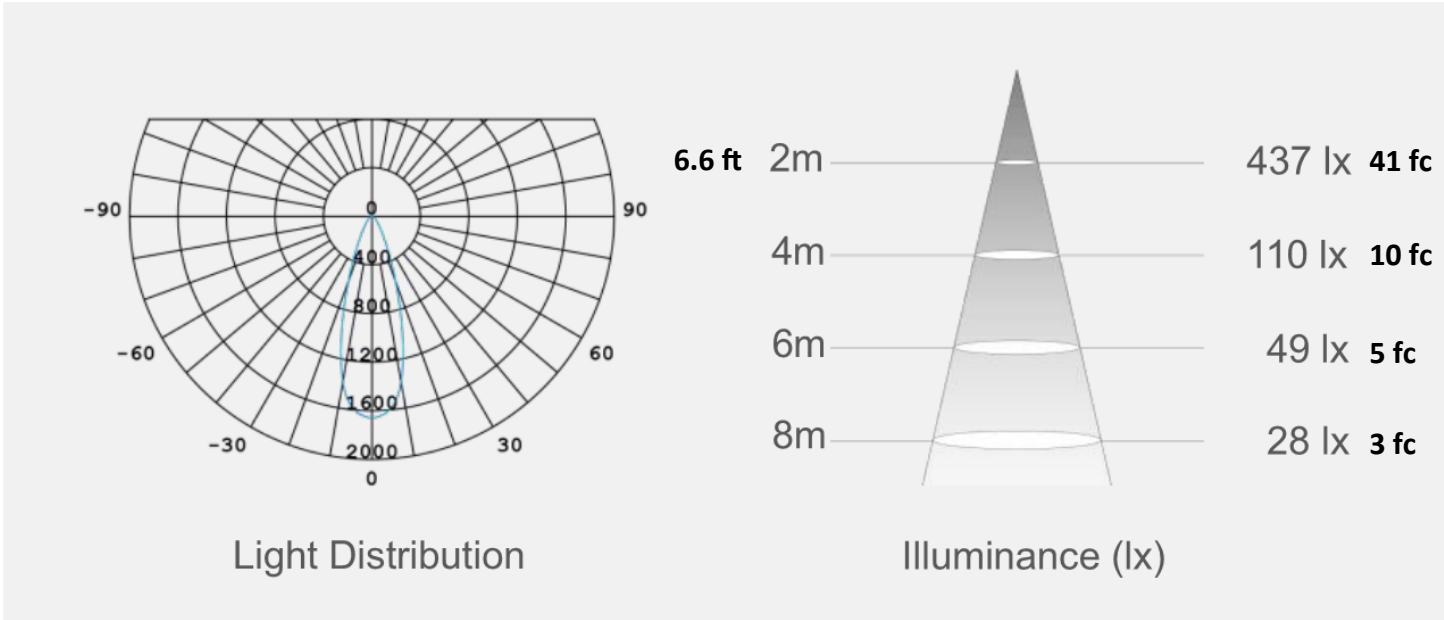
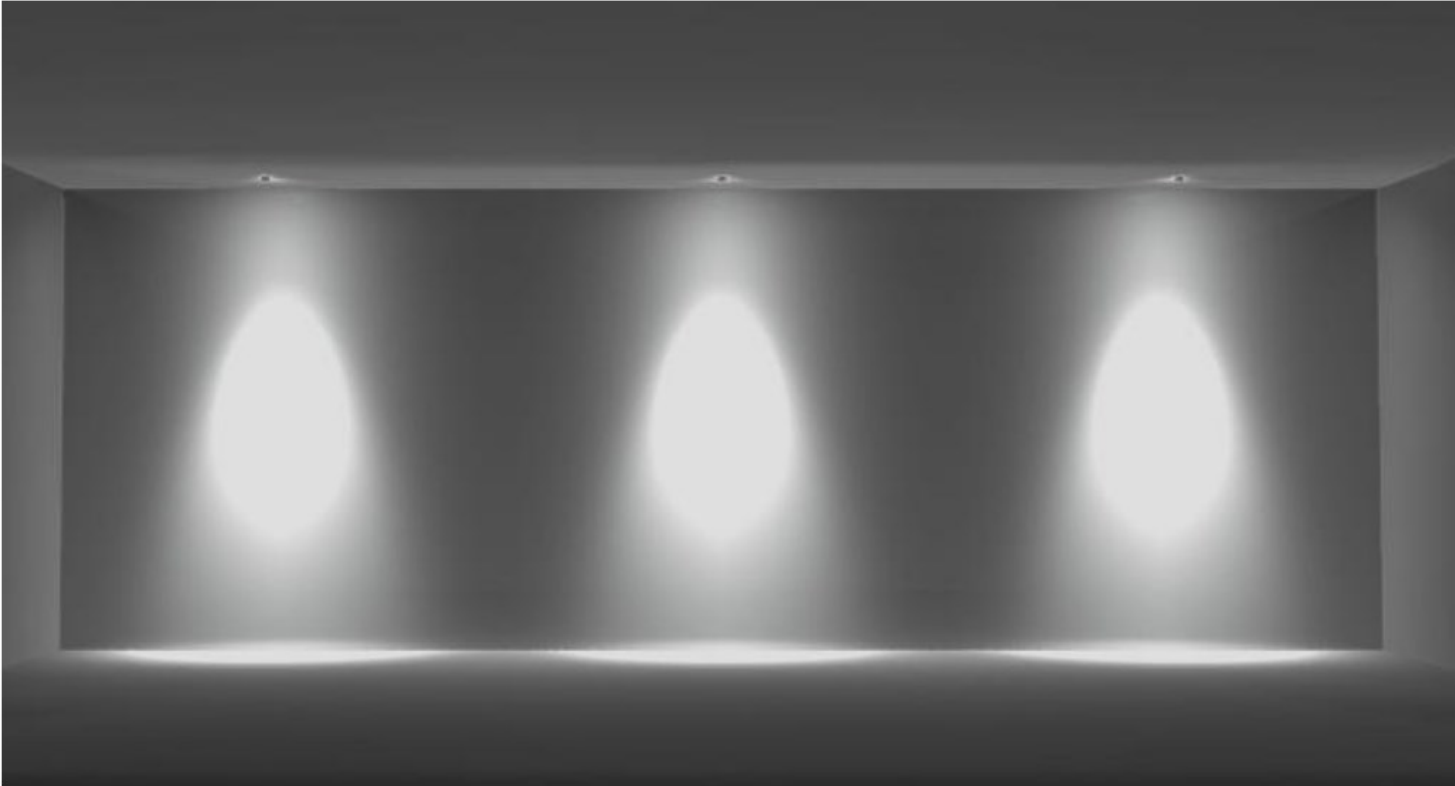

Performance

IES test result of SQUARE ceiling downlight 38°

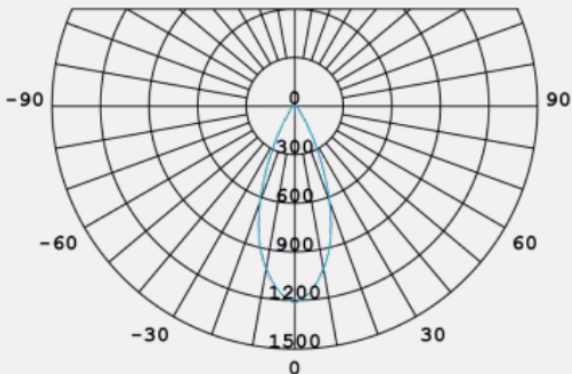
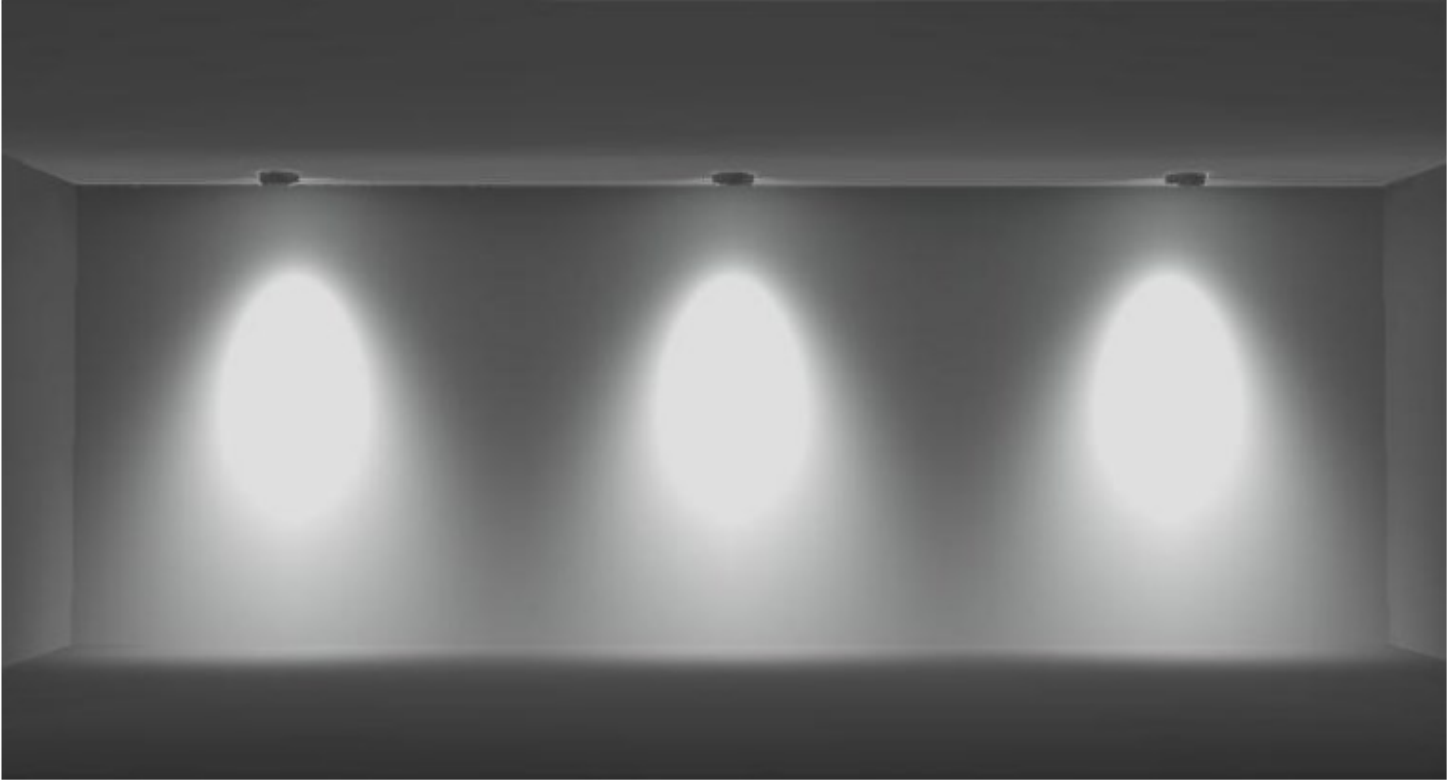

Light Distribution

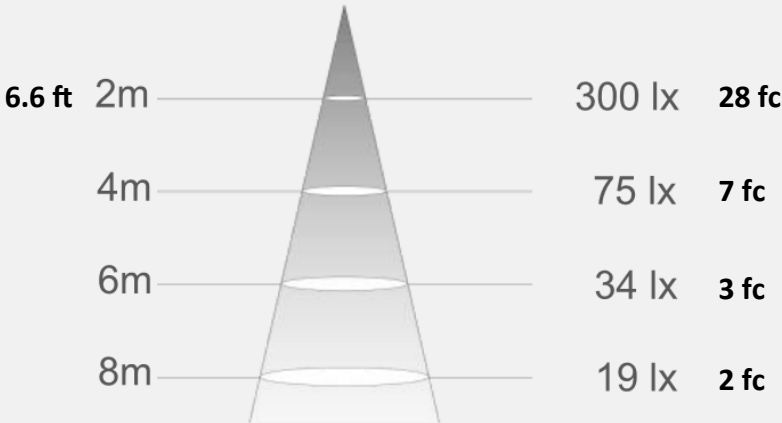

Illuminance (lx)

Photos

Products



Applications

